

Connectors according to DIN 41612 / IEC 60603-2

Type C/2

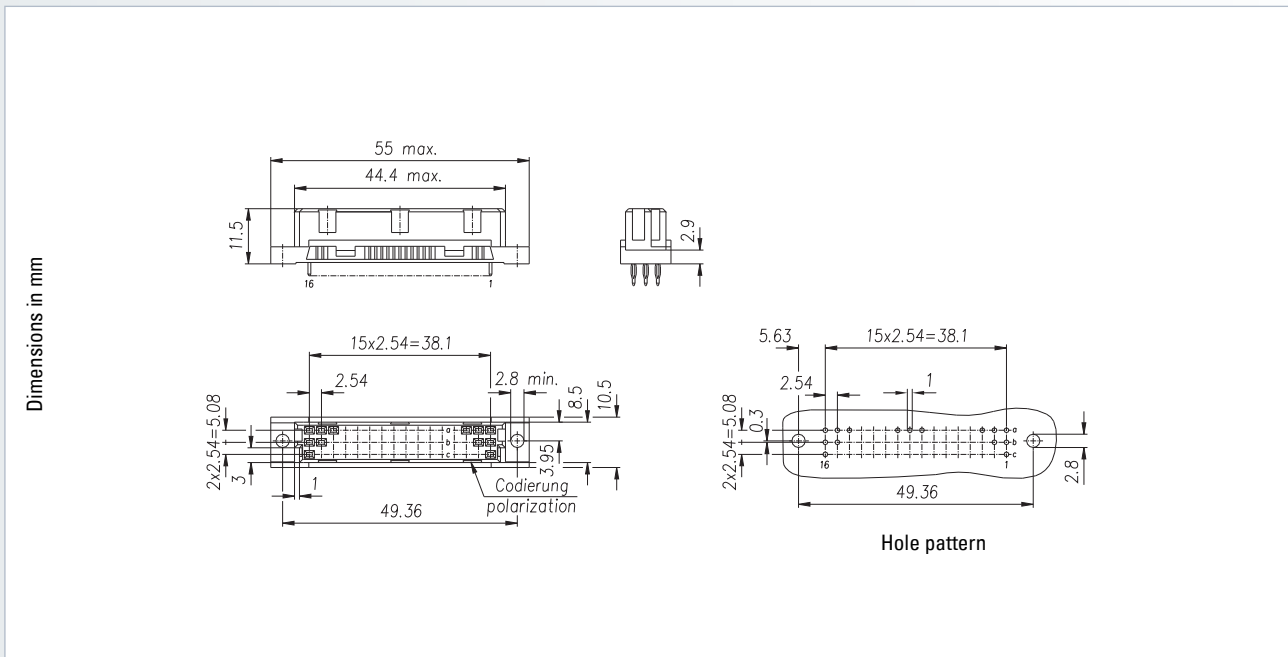

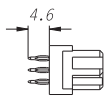
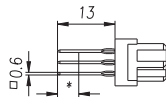
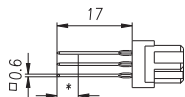
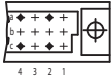
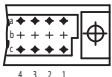
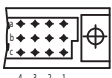

Female connector

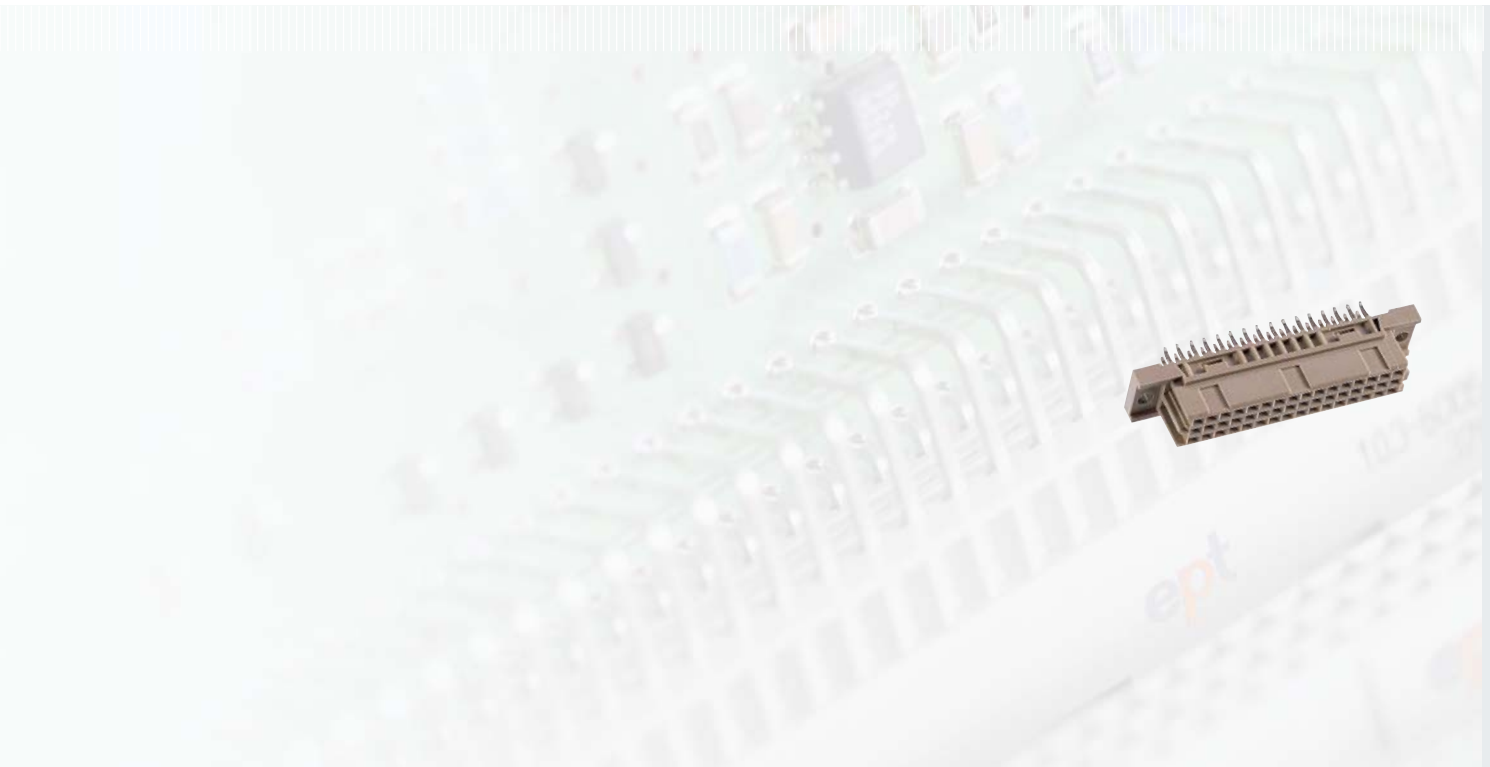

No. of contacts	Contact arrangement	Press-fit technology – Performance level II		
		Termination length		
				
Part number				
16		104-69004-xx	104-79006-xx	104-79106-xx
32		304-69014-02	304-79016-03	304-79116-04
48		304-69064-02	304-79066-03	304-79166-04

Accessories <ul style="list-style-type: none"> – Press-fit tool (see page 208) – Support tool (see page 209) – Coding accessories (see page 160) 	On request <ul style="list-style-type: none"> – Performance levels I + III or customer-specific – Special contact length – Alternative surface Sn, e. g. for WireWrap 	Options <ul style="list-style-type: none"> – Without flange – Contact arrangement (see page 162)
Note <ul style="list-style-type: none"> – * Rear mating zone performance level II 	Ordering note <ul style="list-style-type: none"> Only for 104 <ul style="list-style-type: none"> – PCB 1.5 to 2.0 mm = xxx-xxxx-01 with termination length = 3.2 mm – PCB 2.0 to 2.8 mm = xxx-xxxx-02 with termination length = 4.6 mm – PCB > 2.8 mm = xxx-xxxx-03 with termination length = 4.6 mm 	

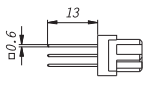

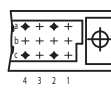
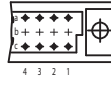
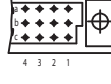
No. of contacts	Contact arrangement	Solder technology – Performance level II				
		Termination length				
						Manual soldering with solder lug 
Part number						
16		104-90004	–	–	104-90006	104-90025
32		304-90014-05	304-90014-01	304-90014-02	304-90016-03	104-90035
48		304-90064-05	304-90064-01	304-90064-02	304-90066-03	104-90075

Accessories – Coding accessories (see page 160)	On request – Performance levels I + III or customer-specific – Special contact length – Also in THTR	Options – Board lock (see page 159) – Contact arrangement (see page 162)
---	--	---