

**HLMP-1301, HLMP-1401, HLMP-1503,  
HLMP-K401, HLMP-K600**  
T-1 (3 mm) Diffused LED Lamps



**Data Sheet**



**Description**

This family of T-1 lamps is widely used in general-purpose indicator applications. Diffusants, tints, and optical design are balanced to yield superior light output and wide viewing angles. Several intensity choices are available in each color for increased design flexibility.

**Features**

- High intensity
- Choice of 4 bright colors:
  - High Efficiency Red
  - Orange
  - Yellow
  - High Performance Green
- Popular T-1 diameter package
- Selected minimum intensities
- Wide viewing angle
- General purpose leads
- Reliable and rugged
- Available on tape and reel

**Package Dimensions**

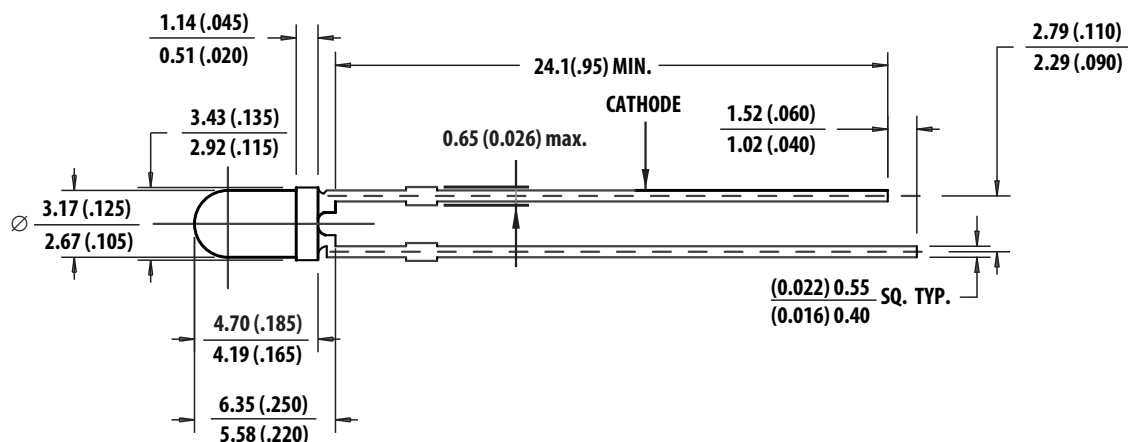

**Notes:**

1. All dimensions are in mm (inches).
2. An epoxy meniscus may extend about 1 mm (0.040") down the leads.
3. For PCB hole recommendations, see the Precautions section.

## Selection Guide

| Material     | Color                        | Part Number     | Luminous Intensity I <sub>v</sub> (mcd) at 10 mA |      |
|--------------|------------------------------|-----------------|--|------|
|              |                              |                 | Min.   | Max. |
| GaAsP on GaP | Red                          | HLMP-1301       | 3.4  | –    |
|              |                              | HLMP-1301-E00xx | 3.4  | –    |
|              |                              | HLMP-1301-FG0xx | 5.4  | 17.2 |
|              |                              | HLMP-1301-G00xx | 8.6  | –    |
|              |                              | HLMP-1301-GH0xx | 8.6  | 27.6 |
|              | Yellow                       | HLMP-1401       | 2.2  | –    |
|              |                              | HLMP-1401-D00xx | 3.6  | –    |
|              |                              | HLMP-1401-E00xx | 5.7  | –    |
|              |                              | HLMP-1401-EF0xx | 5.7  | 18.4 |
|              |                              | HLMP-1401-EFBxx | 5.7  | 18.4 |
|              | Orange                       | HLMP-K401       | 2.1  | –    |
|              |                              | HLMP-K401-E00xx | 3.4  | –    |
|              |                              | HLMP-K401-EF0xx | 3.4  | 10.8 |
|              |                              | HLMP-K401-FGDxx | 5.4  | 17.2 |
| GaP          | Green                        | HLMP-1503       | 1.0  | –    |
|              |                              | HLMP-1503-C00xx | 2.6  | –    |
|              |                              | HLMP-1503-D00xx | 4.2  | –    |
|              |                              | HLMP-1503-DE0xx | 4.2  | 13.4 |
|              |                              | HLMP-1503-DEDxx | 4.2  | 13.4 |
|              | Emerald Green <sup>[1]</sup> | HLMP-K600       | 1.0  | –    |

Note:

1. Please refer to Application Note 1061 for information comparing standard green and emerald green light output degradation...

## Part Numbering System

HLMP - X X XX - X X X XX



## Absolute Maximum Ratings at $T_A = 25\text{ }^\circ\text{C}$

| Parameter   | HER/Orange  | Yellow      | Green       | Units            |
|---|-------------|-------------|-------------|------------------|
| Peak Forward Current  | 90          | 60          | 90          | mA               |
| Average Forward Current <sup>[1]</sup>                              | 25          | 20          | 25          | mA               |
| DC Current <sup>[2]</sup>   | 30          | 20          | 30          | mA               |
| Reverse Voltage ( $I_R = 100\text{ }\mu\text{A}$ )                  | 5           | 5           | 5           | V                |
| Transient Forward Current <sup>[4]</sup> (10 $\mu\text{sec}$ Pulse) | 500         | 500         | 500         | mA               |
| LED Junction Temperature  | 110         | 110         | 110         | $^\circ\text{C}$ |
| Operating Temperature Range   | -40 to +100 | -40 to +100 | -20 to +100 | $^\circ\text{C}$ |
| Storage Temperature Range   | -40 to +100 | -40 to +100 | -40 to +100 | $^\circ\text{C}$ |

### Notes:

1. See Figure 5 (HER/Orange), 10 (Yellow), or 15 (Green/Emerald Green) to establish pulsed operating conditions.
2. For Red, Orange, and Green series derate linearly from  $50\text{ }^\circ\text{C}$  at  $0.5\text{ mA}/^\circ\text{C}$ . For Yellow series derate linearly from  $50\text{ }^\circ\text{C}$  at  $0.2\text{ mA}/^\circ\text{C}$ .
3. For Red, Orange, and Green series derate power linearly from  $25\text{ }^\circ\text{C}$  at  $1.8\text{ mW}/^\circ\text{C}$ . For Yellow series derate power linearly from  $50\text{ }^\circ\text{C}$  at  $1.6\text{ mW}/^\circ\text{C}$ .
4. The transient peak current is the maximum non-recurring peak current that can be applied to the device without damaging the LED die and wirebond. It is not recommended that the device be operated at peak currents beyond the peak forward current listed in the Absolute Maximum Ratings.

## Electrical Characteristics at $T_A = 25\text{ }^\circ\text{C}$

| Symbol                | Description   | Device HLMP-        | Min. | Typ. | Max. | Units              | Test Conditions                    |
|-----------------------|---|---------------------|------|------|------|--------------------|------------------------------------|
| $2\theta^{1/2}$       | Included Angle Between Half Luminous Intensity Points | All                 |      | 60   |      | Deg.               | $I_F = 10\text{ mA}$<br>See Note 1 |
| $\lambda_{PEAK}$      | Peak Wavelength                                       | High Efficiency Red |      | 635  |      | nm                 | Measurement at Peak                |
|                       |   | Orange              |      | 600  |      |                    |                                    |
|                       |   | Yellow              |      | 583  |      |                    |                                    |
|                       |   | Green               |      | 565  |      |                    |                                    |
|                       |   | Emerald Green       |      | 558  |      |                    |                                    |
| $\lambda_d$           | Dominant Wavelength                                   | High Efficiency Red |      | 626  |      | nm                 | See Note 2                         |
|                       |   | Orange              |      | 602  |      |                    |                                    |
|                       |   | Yellow              |      | 585  |      |                    |                                    |
|                       |   | Green               |      | 569  |      |                    |                                    |
|                       |   | Emerald Green       |      | 560  |      |                    |                                    |
| $\Delta\lambda^{1/2}$ | Spectral Line Halfwidth                               | High Efficiency Red |      | 40   |      | nm                 |                                    |
|                       |   | Yellow              |      | 36   |      |                    |                                    |
|                       |   | Green               |      | 28   |      |                    |                                    |
|                       |   | Emerald Green       |      | 24   |      |                    |                                    |
| $\tau_s$              | Speed of Response                                     | High Efficiency Red |      | 90   |      | ns                 |                                    |
|                       |   | Orange              |      | 280  |      |                    |                                    |
|                       |   | Yellow              |      | 90   |      |                    |                                    |
|                       |   | Green               |      | 500  |      |                    |                                    |
|                       |   | Emerald Green       |      | 3100 |      |                    |                                    |
| C                     | Capacitance   | High Efficiency Red |      | 11   |      | pF                 | $V_F = 0;$<br>$f = 1\text{ MHz}$   |
|                       |   | Orange              |      | 4    |      |                    |                                    |
|                       |   | Yellow              |      | 15   |      |                    |                                    |
|                       |   | Green               |      | 18   |      |                    |                                    |
|                       |   | Emerald Green       |      | 35   |      |                    |                                    |
| $R\theta_{J-PIN}$     | Thermal Resistance                                    | All                 |      | 290  |      | $^\circ\text{C/W}$ | Junction to Cathode Lead           |
| $V_F$                 | Forward Voltage                                       | HER/Orange          | 1.5  | 1.9  | 2.4  | V                  | $I_F = 10\text{ mA}$               |
|                       |   | Yellow              | 1.5  | 2.0  | 2.4  |                    |                                    |
|                       |   | Green               | 1.5  | 2.1  | 2.7  |                    |                                    |
|                       |   | Emerald Green       |      | 2.1  | 2.7  |                    |                                    |
| $V_R$                 | Reverse Breakdown Voltage                             | All                 | 5.0  |      |      | V                  | $I_R = 100\text{ }\mu\text{A}$     |
| $\eta_V$              | Luminous Efficacy                                     | High Efficiency Red |      | 145  |      | lumens             | See Note 3                         |
|                       |   | Orange              |      | 380  |      | watt               |                                    |
|                       |   | Yellow              |      | 500  |      |                    |                                    |
|                       |   | Green               |      | 595  |      |                    |                                    |
|                       |   | Emerald Green       |      | 655  |      |                    |                                    |

### Notes:

- $\theta^{1/2}$  is the off-axis angle at which the luminous intensity is half the axial luminous intensity.
- The dominant wavelength,  $\lambda_d$ , is derived from the CIE chromaticity diagram and represents the single wavelength which defines the color of the device.
- Radiant intensity,  $I_e$ , in watts/steradian, may be found from the equation  $I_e = I_v/\eta_v$ , where  $I_v$  is the luminous intensity in candelas and  $\eta_v$  is the luminous efficacy in lumens/watt.

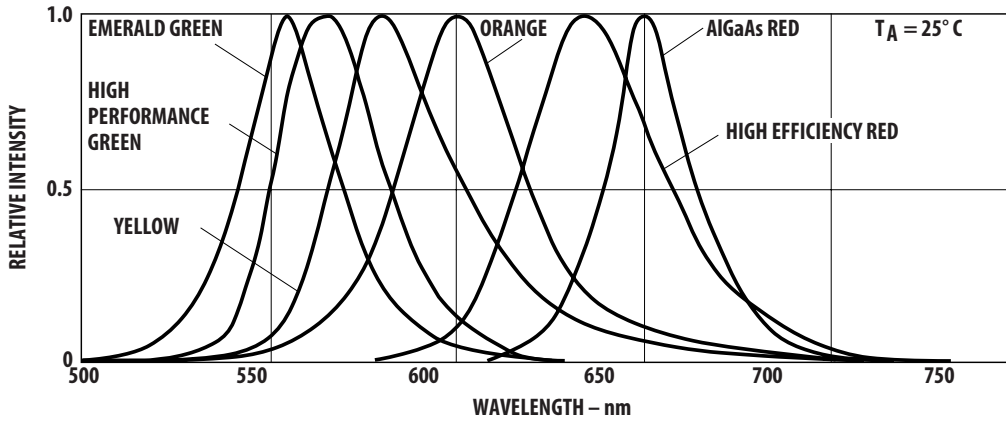

Figure 1. Relative intensity vs. wavelength

### T-1 High Efficiency Red, Orange Diffused Lamps

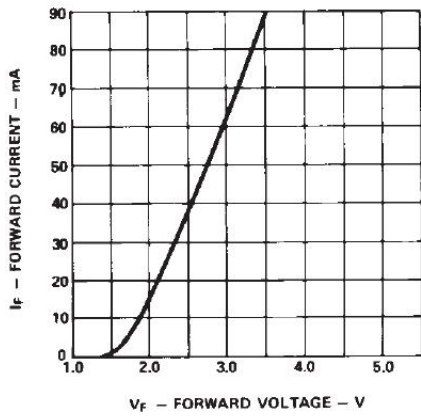

Figure 2. Forward current vs. forward voltage characteristics

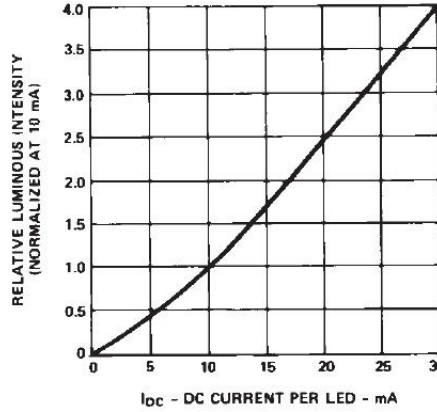

Figure 3. Relative luminous intensity vs. DC forward current

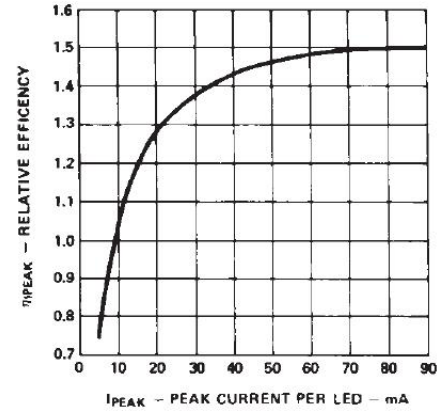

Figure 4. Relative efficiency (luminous intensity per unit current) vs. peak LED current

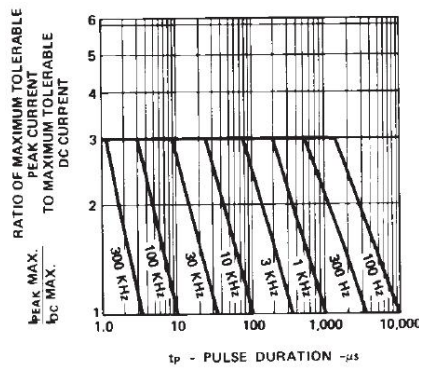

Figure 5. Maximum tolerable peak current vs. pulse duration. ( $I_{DC}$  MAX as per MAX ratings)



Figure 6. Relative luminous intensity vs. angular displacement

## T-1 Yellow Diffused Lamps



Figure 7. Forward current vs. forward voltage characteristics



Figure 8. Relative luminous intensity vs. forward current



Figure 9. Relative efficiency (luminous intensity per unit current) vs. peak current

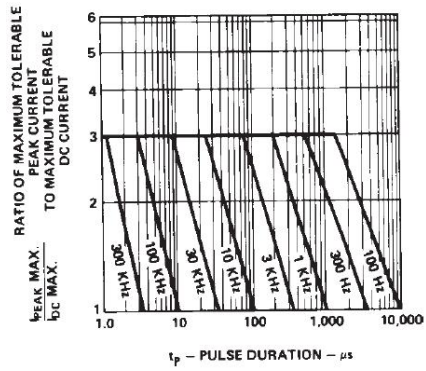

Figure 10. Maximum tolerable peak current vs. pulse duration. ( $I_{DC}$  MAX as per MAX ratings)

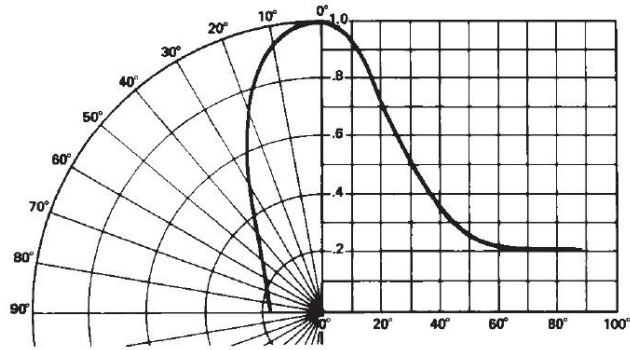

Figure 11. Relative luminous intensity vs. angular displacement

## T-1 Green/Emerald Green Diffused Lamps



Figure 12. Forward current vs. forward voltage characteristics



Figure 13. Relative luminous intensity vs. forward current

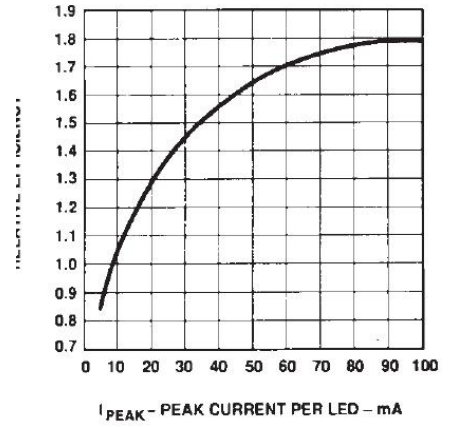

Figure 14. Relative efficiency (luminous intensity per unit current) vs. peak LED current

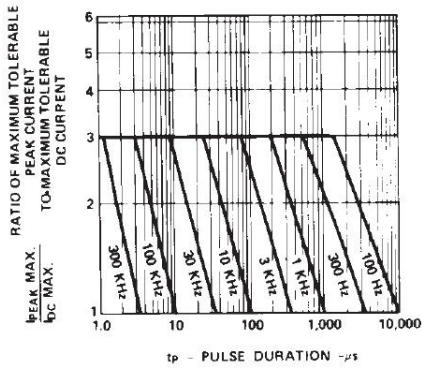

Figure 15. Maximum tolerable peak current vs. pulse duration. ( $I_{DC}$  MAX as per MAX ratings)



Figure 16. Relative luminous intensity vs. angular displacement



## Intensity Bin Limits

| Color      | Bin     | Intensity Range (mcd) |         |
|------------|---------|-----------------------|---------|
|            |         | Min.                  | Max.    |
| Red/Orange | D       | 2.4                   | 3.8     |
|            | E       | 3.8                   | 6.1     |
|            | F       | 6.1                   | 9.7     |
|            | G       | 9.7                   | 15.5    |
|            | H       | 15.5                  | 24.8    |
|            | I       | 24.8                  | 39.6    |
|            | J       | 39.6                  | 63.4    |
|            | K       | 63.4                  | 101.5   |
|            | L       | 101.5                 | 162.4   |
|            | M       | 162.4                 | 234.6   |
|            | N       | 234.6                 | 340.0   |
|            | O       | 340.0                 | 540.0   |
|            | P       | 540.0                 | 850.0   |
|            | Q       | 850.0                 | 1200.0  |
|            | R       | 1200.0                | 1700.0  |
|            | S       | 1700.0                | 2400.0  |
|            | T       | 2400.0                | 3400.0  |
|            | U       | 3400.0                | 4900.0  |
|            | V       | 4900.0                | 7100.0  |
|            | W       | 7100.0                | 10200.0 |
| X          | 10200.0 | 14800.0               |         |
| Y          | 14800.0 | 21400.0               |         |
| Z          | 21400.0 | 30900.0               |         |
| Yellow     | C       | 2.5                   | 4.0     |
|            | D       | 4.0                   | 6.5     |
|            | E       | 6.5                   | 10.3    |
|            | F       | 10.3                  | 16.6    |
|            | G       | 16.6                  | 26.5    |
|            | H       | 26.5                  | 42.3    |
|            | I       | 42.3                  | 67.7    |
|            | J       | 67.7                  | 108.2   |
|            | K       | 108.2                 | 173.2   |
|            | L       | 173.2                 | 250.0   |
|            | M       | 250.0                 | 360.0   |
|            | N       | 360.0                 | 510.0   |
|            | O       | 510.0                 | 800.0   |
|            | P       | 800.0                 | 1250.0  |
|            | Q       | 1250.0                | 1800.0  |
|            | R       | 1800.0                | 2900.0  |
|            | S       | 2900.0                | 4700.0  |
| T          | 4700.0  | 7200.0                |         |
| U          | 7200.0  | 11700.0               |         |
| V          | 11700.0 | 18000.0               |         |
| W          | 18000.0 | 27000.0               |         |

**Intensity Bin Limits, continued**

| Color                   | Bin     | Intensity Range (mcd) |        |
|-------------------------|---------|-----------------------|--------|
|                         |         | Min.                  | Max.   |
| Green/<br>Emerald Green | A       | 1.1                   | 1.8    |
|                         | B       | 1.8                   | 2.9    |
|                         | C       | 2.9                   | 4.7    |
|                         | D       | 4.7                   | 7.6    |
|                         | E       | 7.6                   | 12.0   |
|                         | F       | 12.0                  | 19.1   |
|                         | G       | 19.1                  | 30.7   |
|                         | H       | 30.7                  | 49.1   |
|                         | I       | 49.1                  | 78.5   |
|                         | J       | 78.5                  | 125.7  |
|                         | K       | 125.7                 | 201.1  |
|                         | L       | 201.1                 | 289.0  |
|                         | M       | 289.0                 | 417.0  |
|                         | N       | 417.0                 | 680.0  |
|                         | O       | 680.0                 | 1100.0 |
|                         | P       | 1100.0                | 1800.0 |
|                         | Q       | 1800.0                | 2700.0 |
|                         | R       | 2700.0                | 4300.0 |
|                         | S       | 4300.0                | 6800.0 |
| T                       | 6800.0  | 10800.0               |        |
| U                       | 10800.0 | 16000.0               |        |
| V                       | 16000.0 | 25000.0               |        |
| W                       | 25000.0 | 40000.0               |        |

Maximum tolerance for each bin limit is  $\pm 18\%$ .

## Color Categories

| Color         | Category # | Lambda (nm) |       |
|---------------|------------|-------------|-------|
|               |            | Min.        | Max.  |
| Emerald Green | 9          | 522.5       | 555.5 |
|               | 8          | 555.5       | 558.5 |
|               | 7          | 558.5       | 561.5 |
|               | 6          | 561.5       | 564.5 |
| Green         | 6          | 561.5       | 564.5 |
|               | 5          | 564.5       | 567.5 |
|               | 4          | 567.5       | 570.5 |
|               | 3          | 570.5       | 573.5 |
|               | 2          | 573.5       | 576.5 |
| Yellow        | 1          | 582.0       | 584.5 |
|               | 3          | 584.5       | 587.0 |
|               | 2          | 587.0       | 589.5 |
|               | 4          | 589.5       | 592.0 |
|               | 5          | 592.0       | 593.0 |
| Orange        | 1          | 597.0       | 599.5 |
|               | 2          | 599.5       | 602.0 |
|               | 3          | 602.0       | 604.5 |
|               | 4          | 604.5       | 607.5 |
|               | 5          | 607.5       | 610.5 |
|               | 6          | 610.5       | 613.5 |
|               | 7          | 613.5       | 616.5 |
|               | 8          | 616.5       | 619.5 |

Tolerance for each bin limit is  $\pm 0.5$  nm.

## Mechanical Option Matrix

| <b>Mechanical Option Code</b> | <b>Definition</b>   |
|-------------------------------|---|
| 00                            | Bulk Packaging, minimum increment 500 pcs/bag                                     |
| 01                            | Tape & Reel, crimped leads, minimum increment 1800 pcs/bag                        |
| 02                            | Tape & Reel, straight leads, minimum increment 1800 pcs/bag                       |
| A1                            | Right Angle Housing, uneven leads, minimum increment 500 pcs/bag                  |
| A2                            | Right Angle Housing, even leads, minimum increment 500 pcs/bag                    |
| BG                            | Tape & Reel, straight leads in 2K increment                                       |
| BJ                            | Tape & Reel, straight leads in 2K increment                                       |
| DD                            | Ammo Pack, straight leads in 2K increment   |
| DJ                            | Ammo Pack, straight leads in 2K increment   |
| EE                            | Ammo Pack, straight leads in 5K increment   |
| R4                            | Tape & Reel, straight leads, counter clockwise, anode lead leaving the reel first |
| VA                            | Ammo Pack, horizontal leads in 2K increment                                       |
| VB                            | Ammo Pack, horizontal leads in 2K increment                                       |
| FG                            | Inventory Control for Customer IDI  |

Note: All categories are established for classification of products. Products may not be available in all categories. Please contact your local Avago representative for further clarification or information.

## Precautions

### Lead Forming

- The leads of an LED lamp may be preformed or cut to length before they are inserted and soldered into the PC board.
- If forming a lead is required before it is soldered, then take care to avoid any excessive mechanical stress induced to the LED package. Otherwise, cut the LED leads to length after soldering at room temperature. The solder joint formed will absorb the mechanical stress of the lead cutting from traveling to the LED chip die attach and wirebond.
- It is recommended that tooling be made precisely and the leads cut to length, rather than relying on your hand.

### Soldering Conditions

- Care must be taken during PCB assembly and soldering process to prevent damage to LED component.
- The closest an LED is allowed to be soldered on board is 1.59 mm below the body (encapsulant epoxy) for those parts without standoff.
- Recommended soldering conditions:

|                      | Wave Soldering | Manual Solder Dipping |
|----------------------|----------------|-----------------------|
| Pre-heat Temperature | 105 °C Max.    | –                     |
| Pre-heat Time        | 30 sec Max.    | –                     |
| Peak Temperature     | 250 °C Max.    | 260 °C Max.           |
| Dwell Time           | 3 sec Max.     | 5 sec Max.            |

- The wave soldering parameter must be set and maintained according to the recommended temperature and dwell time in the solder wave. Customer is advised to periodically check the soldering profile to ensure the soldering profile used always conforms to recommended soldering condition.
- If necessary, use a fixture during soldering process to hold the LED component in the proper orientation with respect to the PCB.
- Proper handling is a must to avoid excessive thermal stresses to LED components when heated. Therefore, the soldered PCB must be allowed to cool to room temperature, 25 °C, before handling.
- To ensure solderability, pay special attention to board fabrication, solder masking, surface plating and lead hole size and component orientation.
- Here are the recommended PC board plated through-hole sizes for LED component leads:

|                              | LED Component Lead Size               | Diagonal               | Plated Through-Hole Diameter           |
|------------------------------|---------------------------------------|------------------------|--|
| Lead size (typ.)             | 0.45 × 0.45 mm<br>(0.018 × 0.018 in.) | 0.636 mm<br>(0.025 in) | 0.98 to 1.08 mm<br>(0.039 to 0.043 in) |
| Dambar shear-off area (max.) | 0.65 mm<br>(0.026 in)                 | 0.919 mm<br>(0.036 in) |  |
| Lead size (typ.)             | 0.50 × 0.50 mm<br>(0.020 × 0.020 in.) | 0.707 mm<br>(0.028 in) | 1.05 to 1.15 mm<br>(0.041 to 0.045 in) |
| Dambar shear-off area (max.) | 0.70 mm<br>(0.028 in)                 | 0.99 mm<br>(0.039 in)  |  |

Note: Refer to application note AN1027 for more information on soldering LED components.



— BOTTOM SIDE OF PCB BOARD  
 - - - TOP SIDE OF PCB BOARD

CONVEYOR SPEED = 1.83 M/MIN (6 FT/MIN)  
 PREHEAT SETTING = 150C (100C PCB)  
 SOLDER WAVE TEMPERATURE = 245C  
 AIR KNIFE AIR TEMPERATURE = 390C  
 AIR KNIFE DISTANCE = 1.91 mm (0.25 IN.)  
 AIR KNIFE ANGLE = 40  
 SOLDER: SN63; FLUX: RMA

NOTE: ALLOW FOR BOARDS TO BE SUFFICIENTLY COOLED BEFORE EXERTING MECHANICAL FORCE.

Figure 17. Recommended wave soldering profile

For product information and a complete list of distributors, please go to our web site: [www.avagotech.com](http://www.avagotech.com)