

The SE 5000 Series is DC Filter.



SE 5000



Description :

- Designed for DC power line.
- Excellent differential and common-mode attenuation.
- High performance,easy to install.
- Custom design acceptable.

Typical Applications :

- Available for all kinds of electronic equipments and measuring instruments
(DC side): switching power supply,Private Branch Exchange(PBX),data communication etc.

Electrical Schematic: :

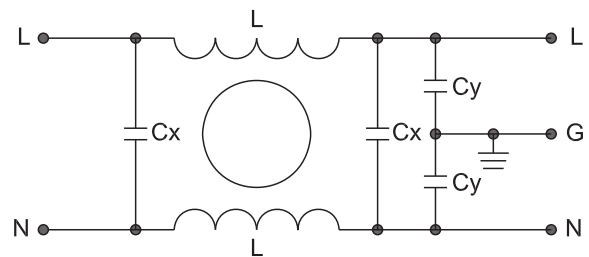



Fig 1

Specification :

Rated Voltage:	80VDC/250VDC
Rated Current:	3A~20A
Operating Frequency:	DC
Temperature range :	HPF 25/085/21
Test Voltage (1min):	
Line to Ground:	500 VDC
Line to Line:	350 VDC

Filter Selection Table :

Filter	Rated current (A)	Rated voltage (V)	Leakage Current (mA)	Input/Output connections 	Electrical Schematic	Dimension
SE5000-3-01	3	80/250	DC	01	1	1
SE5000-6-01	6	80/250	DC	01	1	1
SE5000-10-01	10	80/250	DC	01	1	1
SE5000-16-01	16	80/250	DC	01	1	2
SE5000-20-01	20	80/250	DC	01	1	2

Outline Drawing and Dimensions:

(Unit:mm)

All dimensions in mm; 1 inch=25.4mm

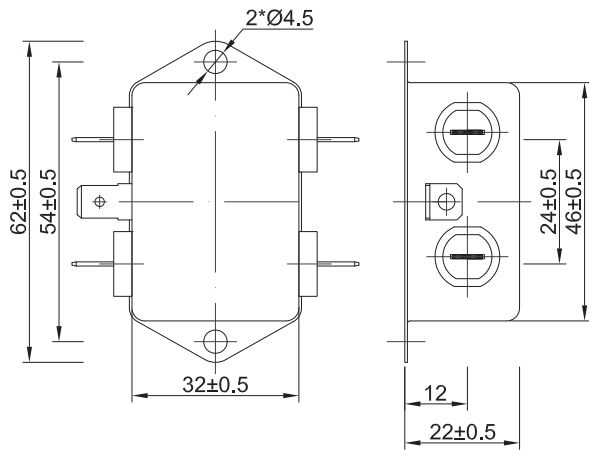

Fig 1

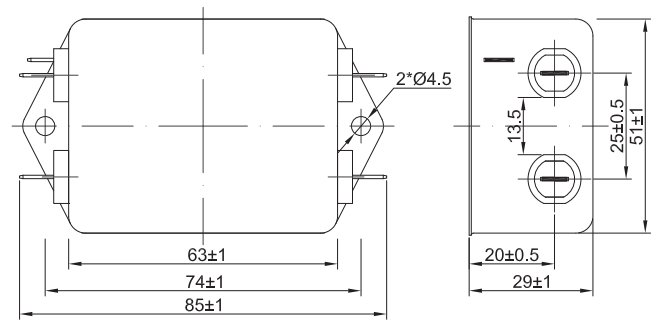
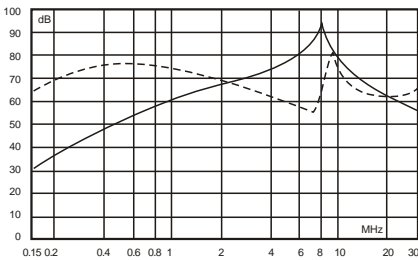

Fig 2

Insertion Loss in dB:

(Measured in 50Ω system , as IEC/CISPR NO.17)



3A

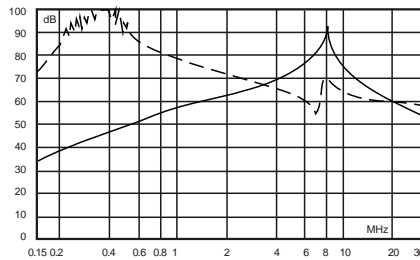

6A

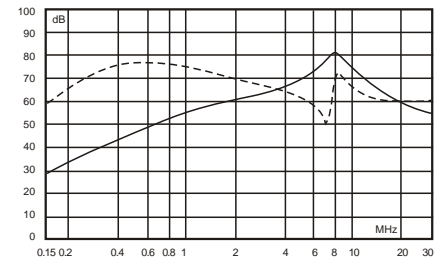

10A

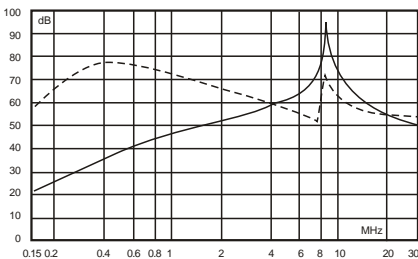

16A

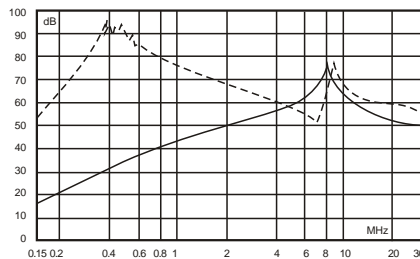

20A

----- Differential Mode
 ——— Common Mode