

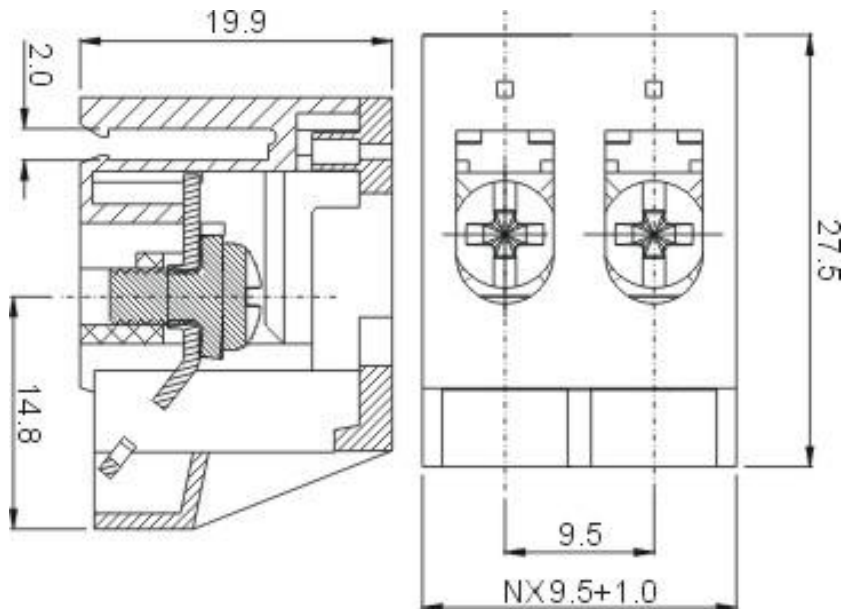





**TSB2.5**

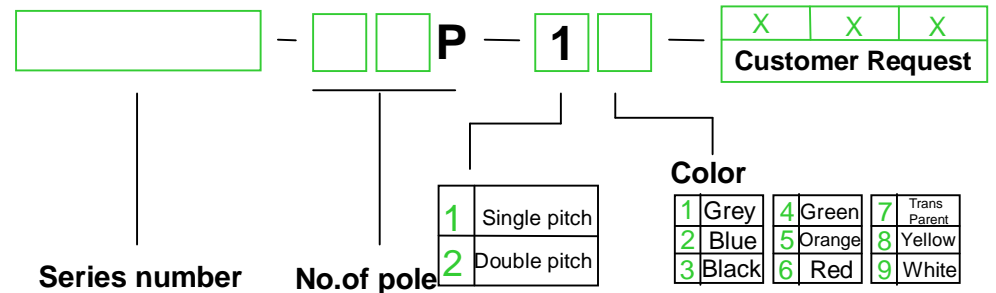

<b>APPROVAL</b>		
<b>Electrical</b>		
Standard	<b>UL</b>	<b>IEC</b>
Rated voltage	300V	250V
Rated current	10A	24A
Wire range	20-12AWG	0.5-2.5mm <sup>2</sup>
Withstanding voltage	AC2000V/1Min	
<b>Mechanical</b>		
Torque	0.5Nm(4.4Lb-In)	
Ambient temperature	-40°C~+105°C	
Strip length	8-10mm	
<b>Dimensions</b>		
Pitch	9.5mm(.374")	
Poles	2P	
<b>Material</b>		
Housing	PA66,UL94V-0	
Screws	M3, Steel,Cr <sup>3+</sup> Zn plated	
Contact	Copper, Tin plated	

**HOW TO ORDER :**

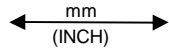

	 <b>DEGSON ELECTRONICS CO., LTD.</b>
	<b>NAME</b> <b>TSB2.5</b>